

EXPLODED DRAWING A

Model No. PFTL69921-INT.3 R0821A

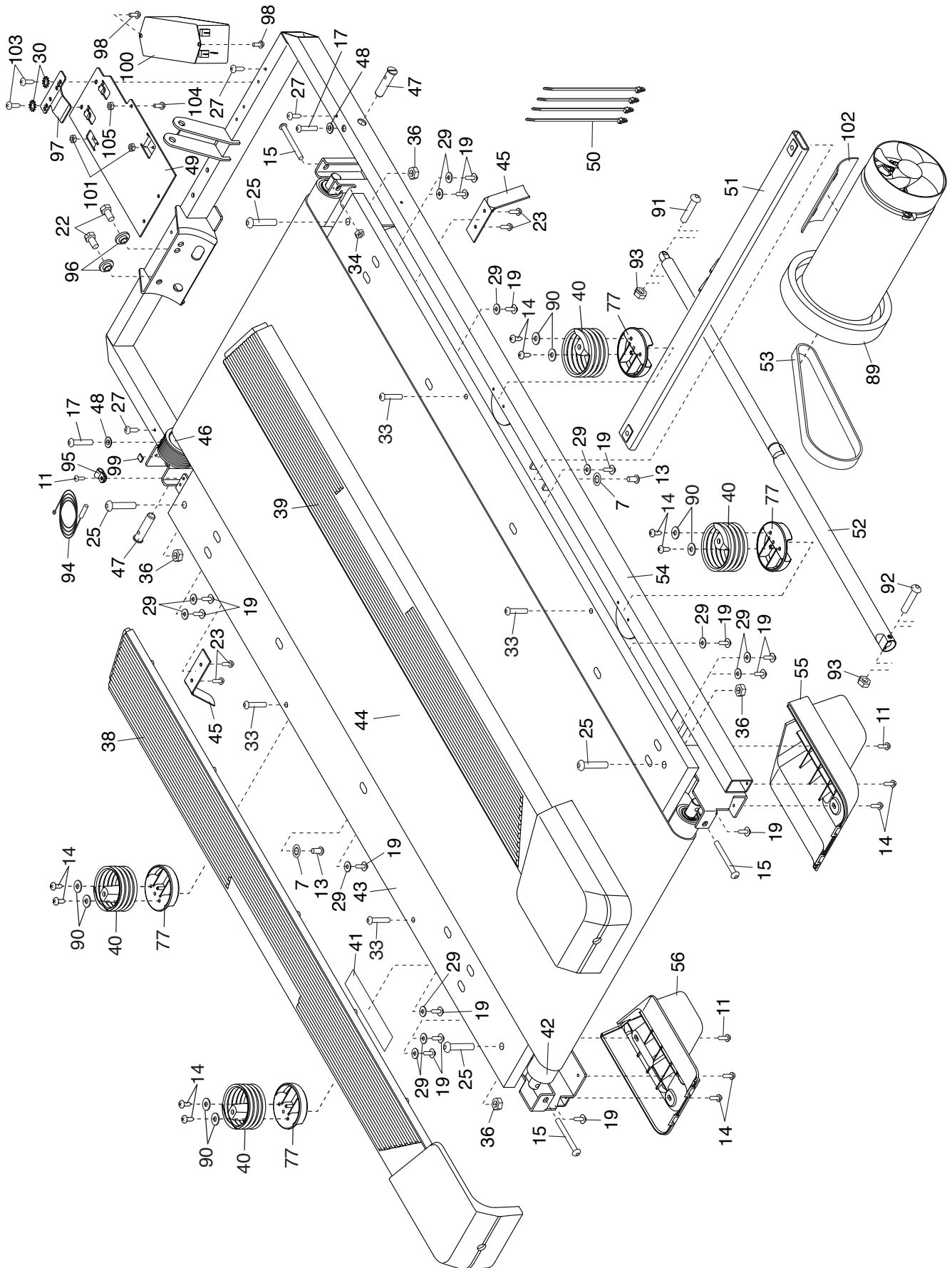

EXPLODED DRAWING B

Model No. PFTL69921-INT.3 R0821A

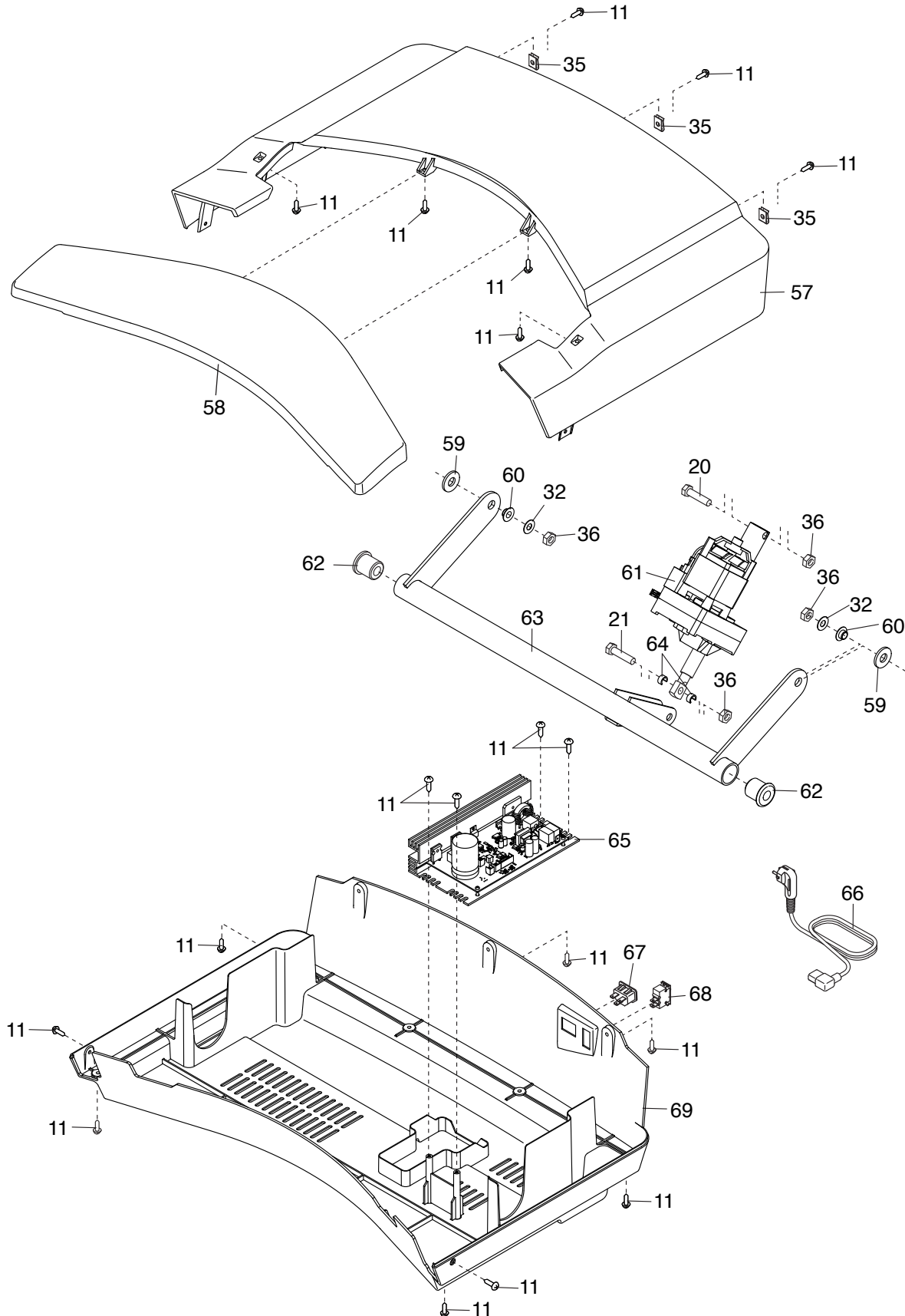

EXPLODED DRAWING C

Model No. PFTL69921-INT.3 R0821A

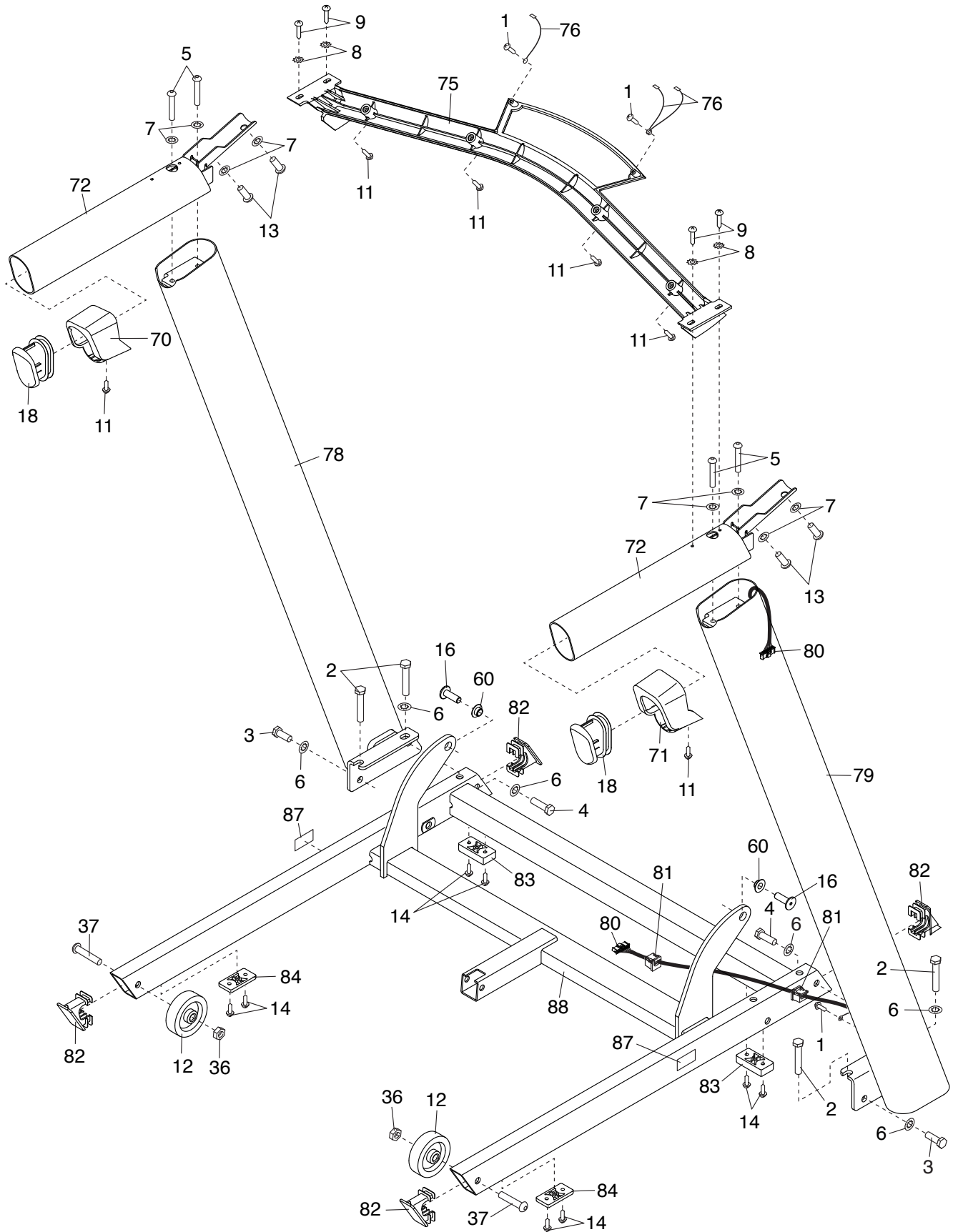

EXPLODED DRAWING D

Model No. PFTL69921-INT.3 R0821A

